

# Gearbox Operations Playbook

A detailed technical line drawing of a gearbox assembly, showing various gears, shafts, and housing components. The drawing is rendered in a light blue color, matching the background, and is positioned behind the main title text.

## Notice and Disclaimer

The information in this document was considered technically sound by the consensus of persons engaged in the development and approval of the document at the time it was developed. Consensus does not necessarily mean there is unanimous agreement among everyone participating in this document's development.

ACP (American Clean Power) disclaims liability for any personal injury, property, or other damages of any nature whatsoever, whether special, indirect, consequential, or compensatory, directly, or indirectly resulting from the publication, use of, application, or reliance on this document. ACP disclaims and makes no guaranty or warranty, express or implied, as to the accuracy or completeness of any information published herein and disclaims and makes no warranty that the information in this document will fulfill any of your particular purposes or needs. ACP does not undertake to guarantee the performance of any individual manufacturer or seller's products or services by virtue of this standard or guide.

In publishing and making this document available, ACP is not undertaking to render professional or other services for or on behalf of any person or entity. Nor is ACP undertaking to perform any duty owed by any person or entity to someone else. Anyone using this document should rely on his or her own independent judgment or, as appropriate, seek the advice of a competent professional in determining the exercise of reasonable care in any given circumstances. Information and other standards on the topic covered by this publication may be available from other sources, which the user may wish to consult for additional views or information not covered by this publication.

ACP has no power, nor does it undertake to police or enforce compliance with the contents of this document. ACP does not certify, test, or inspect products, design or installation for safety or health purposes. Any certification or other statement of compliance with any health or safety-related information in this document shall not be attributable to ACP and is solely the responsibility of the certifier or maker of the statement.

If you breach this agreement, your right to further use this Document will be immediately revoked.

This document is proprietary, and its use is subject to a legally binding license agreement and disclaimer (the "Agreement"). Do not use this document for any purpose unless and until you read the agreement. By viewing or otherwise using this document, you hereby warrant and represent that you have read and agree to be legally bound by the agreement and are authorized to bind not only yourself to the agreement, but the organization for which you are accessing the document. If the agreement is not acceptable and you are unwilling to be bound by it, please do not view, or otherwise make any use of the document.

## Published by

American Clean Power Association  
1501 M Street, NW, Suite 900  
Washington, DC 20005  
202.383.2500

## Copyright

©2023 American Clean Power Association. All rights reserved. You may download, reproduce and print this white paper and any portion hereof (the "Document") for internal use only (which use may include internal use by employees of your company), and, by downloading or accessing the Document, you agree: (i) that you shall not sell or otherwise engage in any distribution of this Document; (ii) that you shall not make any alterations, modifications, deletions or other changes to this Document without the express written consent of American Clean Power Association ("ACP"); and (iii) to indemnify and hold AWEA harmless for any loss or damage, including reasonable attorney's fees, that the AWEA may incur, directly or indirectly, as a result of your use of this Document.

ACP assumes no liability for reliance on the contents of this document. ACP is providing this document for reference only in furtherance of ACP's nonprofit and tax-exempt mission. ACP makes no representation or warranty about the information contained in this document, including, without limitation, the suitability of the information contained in this document for any purpose. It is offered only as general guidance and does not constitute legal, medical, or professional advice. This document is not intended to, nor does it, include information regarding safe operations and maintenance practices. Any recommended practices, guidance or standards contained in this document should be considered on a case-by-case basis and used in accordance with your company's internal safety and other operating requirements as well as all applicable laws, regulations and recommended practices addressing safety and regulatory compliance (such as OSHA and ANSI requirements). You should consider seeking legal or professional advice on all matters concerning safety and regulatory compliance.

# Table of Contents

<b>1</b>	<b>Foreword</b>	<b>1</b>
<b>2</b>	<b>Scope</b>	<b>2</b>
<b>3</b>	<b>Configurations</b>	<b>3</b>
<b>4</b>	<b>Gearbox Configurations</b>	<b>4</b>
<b>5</b>	<b>Common Failure Modes</b>	<b>5</b>
<b>6</b>	<b>Maintenance</b>	<b>12</b>
<b>7</b>	<b>Condition Monitoring Systems</b>	<b>14</b>
<b>8</b>	<b>Common Bore Scope Inspection Practices</b>	<b>15</b>

# 1 Forward

As the world continues its transition towards a more sustainable and environmentally responsible energy future, wind power stands at the forefront of this crucial transformation. This playbook will cover the intricate ecosystem of wind turbine drivetrain components, monitoring systems, and maintenance practices, with a specific focus on the vital and often intricate heart of these remarkable machines: the gearboxes.

Wind turbine gearboxes represent the core of converting wind energy into electricity efficiently and reliably. They operate under demanding conditions, enduring extreme temperatures, high wind forces, and constant rotation. Understanding the intricacies of these gearboxes is essential for maximizing energy production, ensuring equipment longevity, and minimizing downtime.

We extend our gratitude to the experts and organizations who have generously shared their knowledge to make this document possible. By fostering collaboration and promoting best practices, we can collectively harness the power of wind to usher in a cleaner, brighter, and more sustainable future.

The American Clean Power Association (ACP)'s Drivetrain Working Group developed the ACP Gearbox Operations Playbook, with the intent to provide guidance for day to day operations of wind turbine gearboxes. Common troubleshooting scenarios and solutions will be discussed. The Drivetrain Working Group represents decades worth of expertise and experience, gained from both wind and other industry sectors. The group's objective is to inform, train and support wind industry technicians, engineers and managers in their efforts to improve reliability and project performance.



## 2 Scope

The information in this document provides high level guidelines for failure mode identification, maintenance, monitoring, and inspection of wind turbine gearboxes. Common troubleshooting scenarios and solutions to those scenarios will be addressed. These contents will best support those who are being introduced to the wind industry or the operation of wind turbine drivetrains.



# 3 Configurations

Drivetrains that utilize gearboxes in wind turbines often fit one of three configurations:

## 1. Three Point Mounted Drivetrain:

The Drivetrain is mounted to the bedplate of the nacelle via generator, gearbox, and one main shaft bearing.

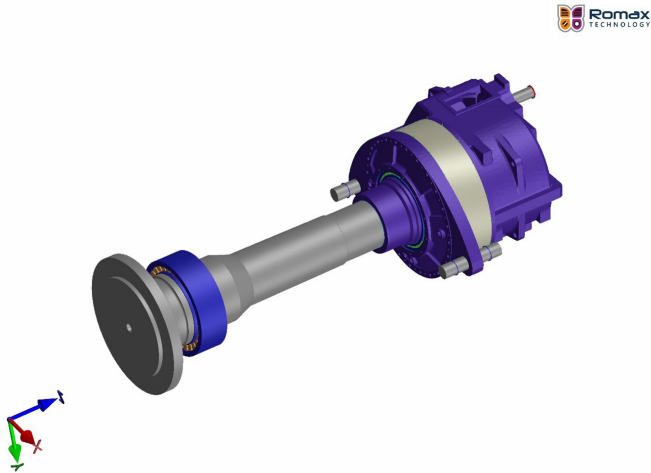

## 2. Four Point Mounted Drivetrain:

The Drivetrain is mounted to the bedplate of the nacelle via generator, gearbox, and two main shaft bearings.

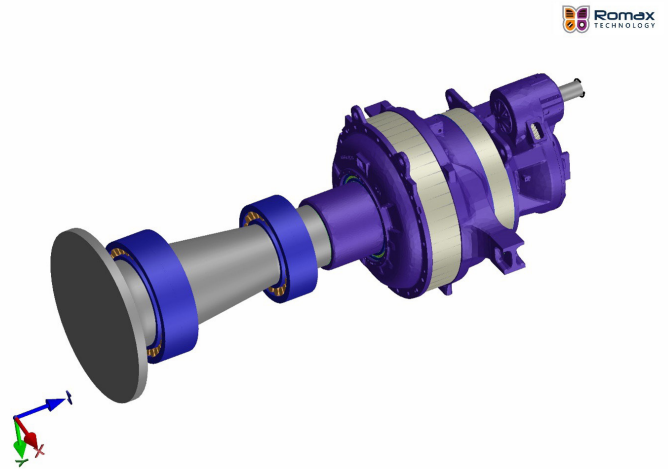

## 3. Integrated Main Bearing System:

The Drivetrain is mounted to the bedplate of the nacelle via generator and gearbox, and the main shaft bearing is integrated into the gearbox.

### Other, less common configurations include the following:

- Three planet stages and a single stage parallel section
- One Helical stage to split drive parallel stage

Images provided by ONYX Insight

# 4 Gearbox Configurations

Today, most wind turbines utilize one of three common gearbox configurations. These configurations are (the upwind side of the gearbox is on the lefthand side of the below images):

1. Two planet stages and a single stage parallel section.

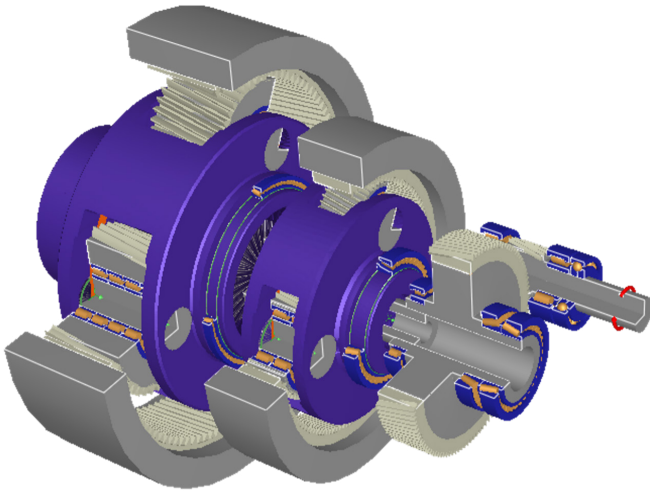

2. One planet stage and a two-stage parallel section.

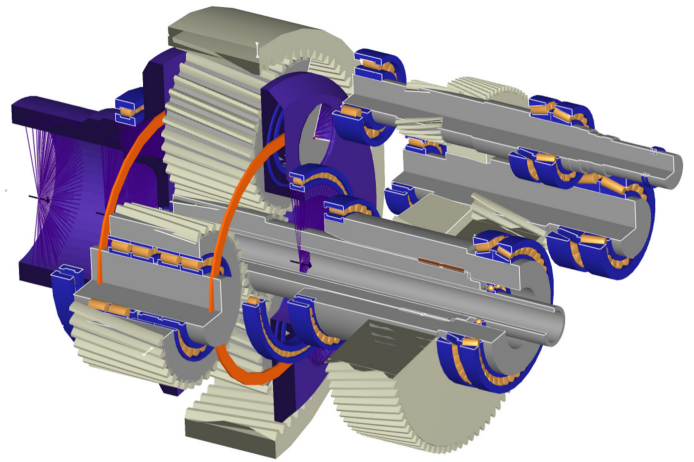

3. Compound planet stage and a single stage parallel section.

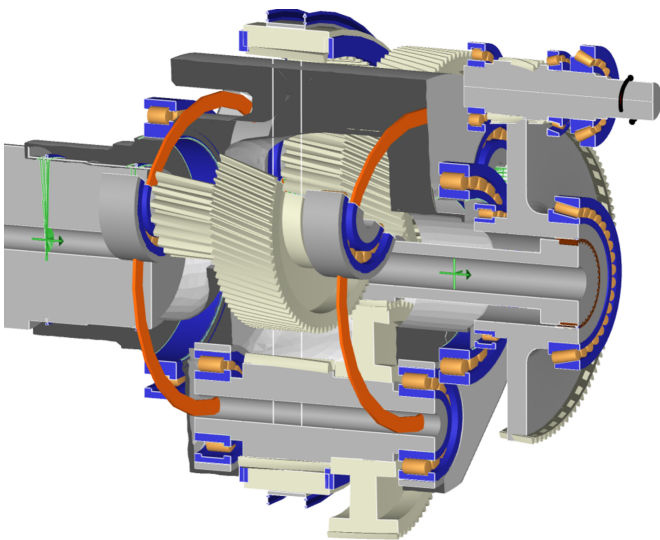

# 5 Common Failure Modes

Drivetrains that utilize gearbox Wind turbine operators managing a drivetrain reliability program should be aware of the range of failure modes that may be experienced in operations. The failure modes discussed below present a range of risks to operations. Some can be considered minor anomalies, while others can quickly result in total failure of the gearbox.

The following are examples of typical damages seen on wind turbine gearing:

## Adhesion

Transfer of material from one gear to the mating gear through micro-welding. Appears shiny and irregularly shaped. This type of damage is typical wear for gears. If adhesion does not progress to pitting, there is minimal concern of impact to daily operations.

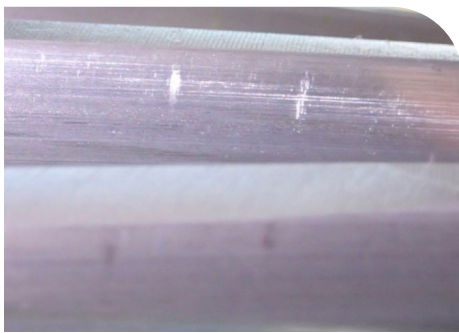

Figure 1: Gear teeth with mild adhesion

## Abrasion

The removal/displacement of gear material due to the presence of hard particles between the teeth. Abrasion can have a darker appearance on the tooth flank or appear as dents or small pits. If the abrasion does not progress to more severe damage, such as pitting or spalling, there is minimal concern of impact to daily operations.

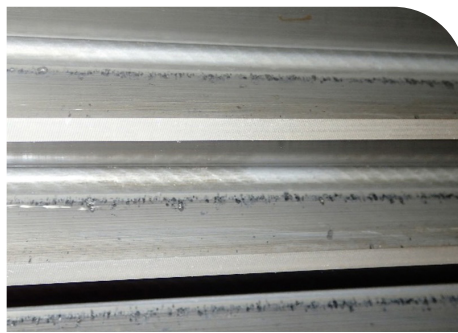

Figure 2: Gear teeth with mild abrasion

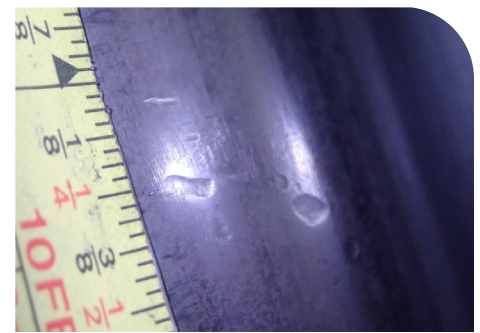

Figure 3: Abrasion in the form of denting on the tooth flank

## False Brinell Mark (Standstill Mark)

This occurs when mating gears are subject to an impact load or smaller oscillating load while the gearbox is not rotating (at standstill). False brinelling usually occurs during transportation of the gearbox or up-tower when the rotor is locked out and the gearing is isolated to small relative motion between mating components. The two mating surfaces polish each other in a line that travels non-parallel to the tooth flank (caused by the helix angles of the teeth). False Brinell marks will often be accompanied by fretting corrosion. These marks typically have little to no impact to operations. However, in rare cases, false Brinell marks can be severe enough to form pitting along their length. This pitting should be monitored for progression regularly. If these marks progress to more severe failure modes, such as macro pitting or spalling, the gear will eventually need to be replaced.

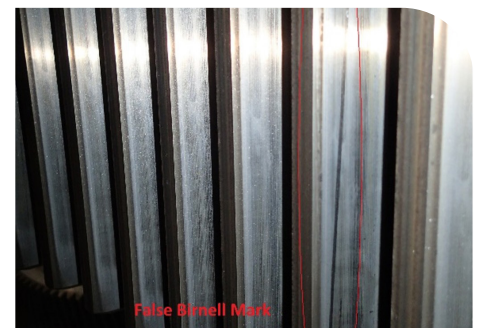

Figure 4: False Brinell Mark



### Fretting Corrosion

Like false brinelling, this is caused by small oscillating (or cyclic) loading in which the movement between the parts is small. The mating gears cause adhesion. The debris produces an iron oxide powder, resulting in the reddish colors in Figure 5. Fretting corrosion will almost always be found accompanying a false Brinell mark. In most cases, the corrosion will be wiped away when normal operation resumes. In some cases, if the corrosion has time to set in, it will form pits along the area of the tooth subjected to the corrosion. If this occurs, and the pits become progressive, the gear will eventually need to be replaced.



Figure 5: False Brinell Mark with Fretting Corrosion

### Plastic deformation

This is permanent deformation of teeth due to overstressing the material. It can be the result of overload, debris interference, or some other factors. Plastic deformation of any gear will lead to premature failure, and the gear will need to be replaced.

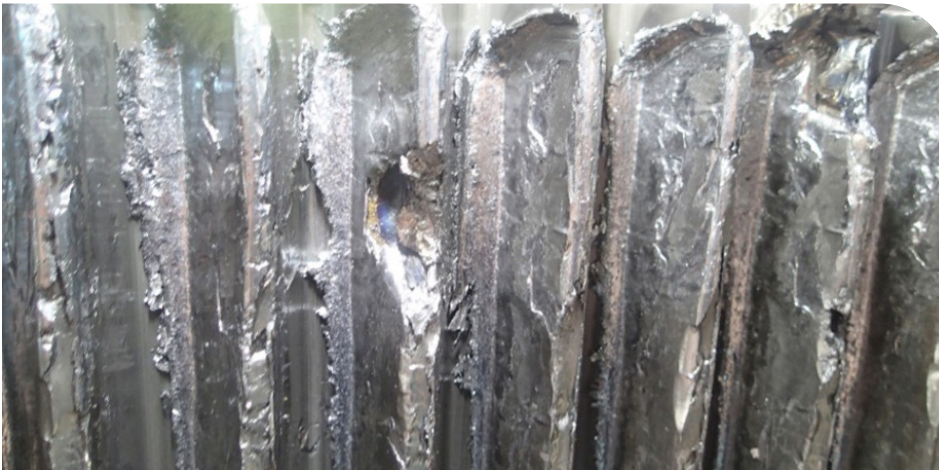

Figure 6: Plastic deformation known as cold flow. In this case the planets interfered with the ring gear tips, pushing the ring gear material toward the root as the planets were rotating.

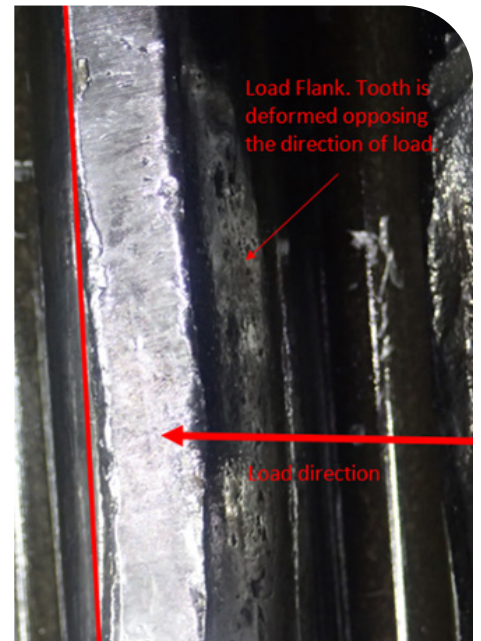

Figure 7: Example of a tooth plastically deformed due to debris

## Pitting

Micro cracks that form at or near the surface of gearing and propagate toward the contact surface. Once long enough, the cracks remove small parts of the tooth surface. Pits will appear rough and jagged in the bottom of the pit and around the edges.

### Micro pitting

Also known as gray staining. Gives a gray appearance and normally has an irregular shape. The gray appearance is due to thousands of microscopic pits coalescing into larger areas of surface damage. This damage is driven by the removal of asperities from the tooth surface. Micro pitting can be progressive if severe enough and can signal issues with the effectiveness of oil lubrication or loading on the contact surface. If found, the gear should be periodically checked. If micro pitting is not progressive, operation may continue as normal. If micro pitting does become progressive, the surface defect will eventually lead to macro pitting or spalling, at which point the gear will eventually need to be replaced.

### Macro pitting

This failure mode appears jagged and reflects more light than micro pitting, resulting in a shinier appearance. The loss of material is accompanied by microcracks in and around the damaged area. This damage usually forms on its own but can also form from severely progressed micro pitting. Once macro pitting has begun the gear will eventually need to be replaced.

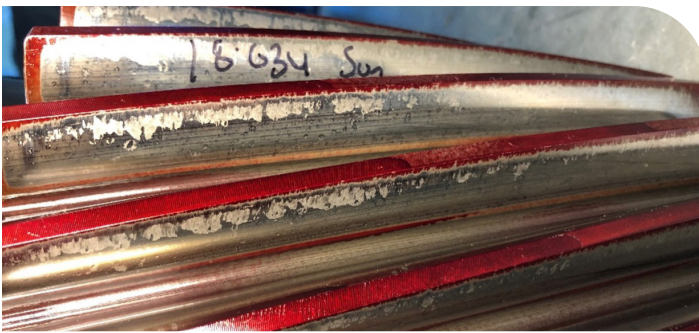

Figure 8: Micro pitting along addenda of gear teeth

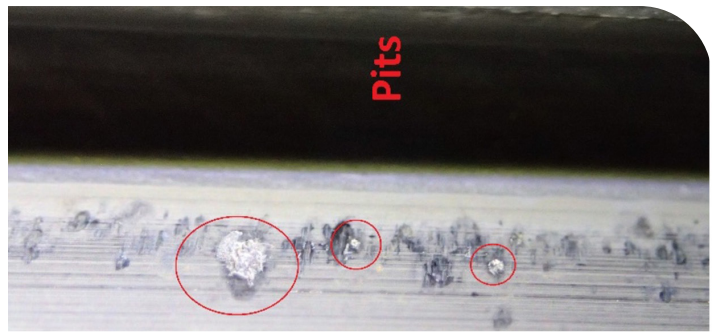

Figure 9: Examples of macro pits on a gear tooth

## Spalling

This failure mode is initiated by stress concentrations caused by existing surface defects. Progressed macro pitting can sometimes initiate spalling. Spalling can vary in size and depth, but once this failure mode has initiated the replacement of the gear will need to be prioritized.



Figure 10: Spalling damage initiated from surface damage at the dedendum of a gear tooth.

## Cracks

Cracks are visible separation of material within itself. Cracks will lead to full fracture of the tooth, but in some cases, if caught early enough, the tooth may still be found intact. This is optimal to find the cause of the failure. If a crack is found, the gear will eventually need to be replaced.



Figure 11: Example of a cracked tooth that is still intact



Figure 12: Example of two cracked teeth, one has progressed enough to remove areas of the surface material, the other is not as progressed.

## Fractures

Partial or whole separation of teeth from the gear itself. Fractures can occur in ductile, brittle, or mixed mode fashion. If a fractured tooth is identified a plan to replace the damaged gearing should be put in place. Continued operation with a fractured gear tooth is dependent upon multiple risk factors such as failure mode, the number fractured teeth and the stage in the gearbox where the damage is identified. Fractures of any kind will eventually render the gear inoperable.

### Ductile Fractures

Appear smooth, shiny, and almost always will be accompanied by fatigue lines (aka beach marks). These beach marks are evidence of the slow progression of the crack through one side of the tooth to the other, until it has grown far enough for the tooth to be liberated from its base completely.

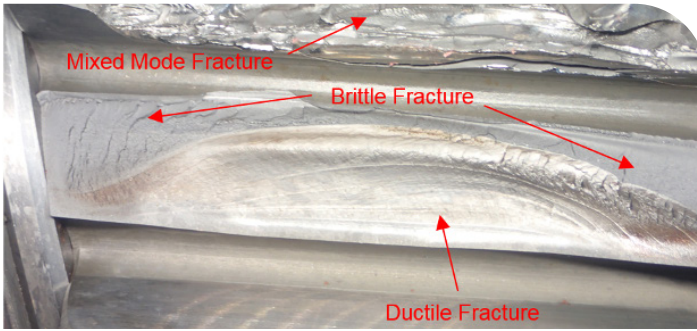

Figure 13: Fracture showing Ductile and Brittle fracture on one tooth, with mixed mode fracture on the adjacent tooth.

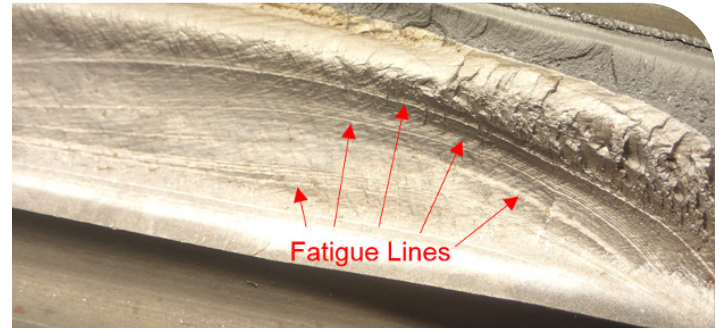

Figure 14: Close up of failure in Fig 13. Fatigue lines (beach marks) are shown for clarification

### Brittle Fractures

Usually rough, jagged, and gray. They occur due to a few short overload cycles of the tooth in which the crack is forced to propagate quickly.



Figure 15: Completely brittle fracture on the tooth to the far right, causing mixed mode fracture of the tooth behind it. Total brittle fractures due to one load cycle are also known as tooth shear.

### Mixed Mode Fractures

Incorporate both ductile and brittle fractures. Usually caused by severe overload that initiates a crack in a brittle fashion. Subsequent loads will then propagate the crack in a ductile fashion. These modes can often alternate until the tooth has fully liberated.



Figure 16: Mixed mode. Mostly brittle fracture shown, as the tooth was overloaded almost to the point of fracture, then the crack propagated in a ductile fashion during subsequent loads until liberation.

## The following are examples of typical damages seen on wind turbine bearings:

### False Brinell Mark (Standstill Marks):

These are like false brinell marks found on gearing and are caused by the same factors. These marks appear straight across the roller and/or race as that is the contact line for bearings (whereas the gears are mostly helical). As with gearing, false Brinell marks on bearings can be accompanied by fretting corrosion. If pitting has not formed from either the false Brinell mark or fretting corrosion, the bearing will be fine to continue operation. If pitting is found, the bearing will need to be checked periodically for signs of progression. If the pitting is progressing, or has turned into spalling, then the bearing will eventually need to be replaced.

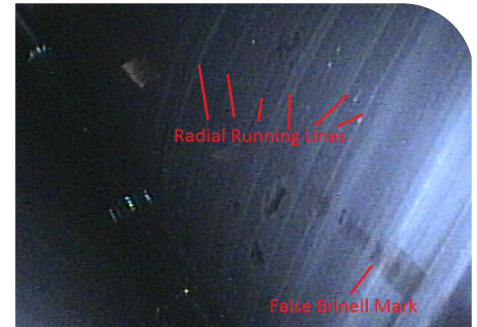

Figure 17: Bearing roller with typical radial running lines and a false Brinell mark. Debris dents can also be seen on the roller.

### Radial Running / Operating Lines

These lines are caused by small debris particles temporarily lodging in one spot (Ex: between a cage and roller). The debris will wear off a very small portion of the roller's surface. Typically, these are seen more on bearings with coating, as the coatings can wear off more easily than the actual surface of the roller. Most of these lines have little or no depth to them, as they are polished surfaces. As with false Brinell marks, if these lines do not form pitting, the bearing is fine for continued operation.



Figure 18: Bearing roller with typical radial running lines

### Bore Spin

Often bearing outer races spin inside their respective bore due to lack of fit, over torquing, or other circumstances. A spinning outer race inside a bore will generate debris, which will cause the bore to grow larger, compounding the problem. If left unchecked, even minor bore spin can cause the bore to become oversized. As a result, the bearings become out of concentricity with their axial partners, causing edge loading, as well as misaligned gear meshes. Up-tower and down-tower pinning solutions are being developed for positions that have a high tendency to spin. When Down-tower the bore can be repair via sleeving, metal spraying, or oversizing the bore for a larger bearing.

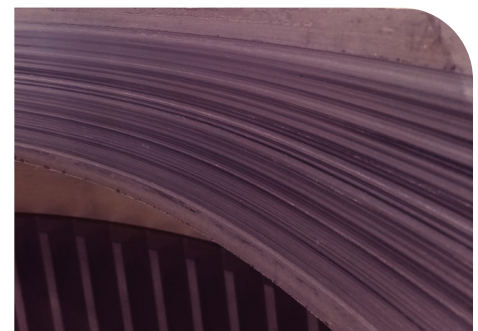

Figure 19: Bearing bore with severe spin damage

### Electrical Fluting

Electrical fluting occurs when a current is passed through the bearing. The current causes localized material to heat up (like micro-welding) and break off, creating frosted areas that look like micro pitting. Electrical fluting is not a common failure mode in wind turbine gearboxes but can be seen if an electrical component (such as the generator) is not grounded properly. If fluting is found, the bearing must be replaced as soon as possible, as the damage will only progress.

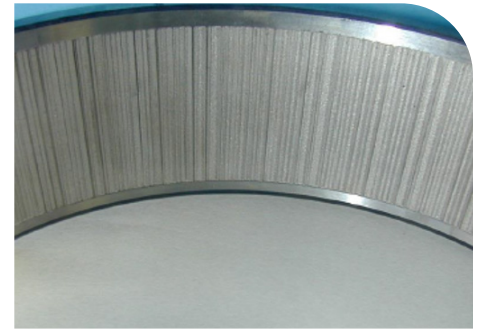

Figure 20: Bearing race with electrical fluting damage

### Debris / Particle Denting

Denting formed when harder foreign particles come into contact with roller and raceway. These are smaller particles and while the indentations are created, they may not progress if the debris is not constant and flushed after a cycle or two. Denting is usually not progressive, so long as it does not form pits. If you see dents that are progressing after a few inspections, but no pitting has formed, it typically means that there is a different component in the gearbox that is failing and shedding debris, causing denting in other areas of the gearbox. In any case, if you see pitting that is progressive, the bearing should eventually be replaced, and the rest of the gearbox should be inspected thoroughly to find the source of the debris.

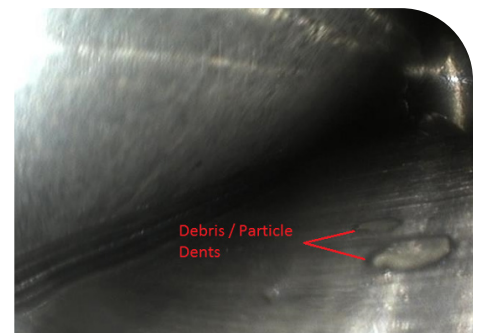

Figure 21: Bearing race with a typical debris / particle dent

### Pitting

Pitting is the formation of microcracks on the surface of the rolling elements of the bearing. As it does with gearing, it can take the form of micro pitting and macro pitting. The formation of the microcracks can be caused by inadequate lube film, the presence of foreign particles, electrical currents, or fatigue stress developing cracks over the life of the bearing. These microcracks will propagate down into the race a short amount, before turning and eventually coming back to the surface. Once this occurs, then the material surrounded by the crack is liberated, and the pit is all that is left. Once the pit is present, it creates a stress concentration in the rolling element, and the edge of the pit may start to develop microcracks itself, and the process starts again.

#### Micro Pitting

Micro pitting can be found on races and/or rollers. Micro pitting can be operated in some cases but may lead to higher operating temperatures depending on severity. It can also develop into macro pitting. In any case, if micro pitting is found, it needs to be periodically checked for progression.



Figure 22: Bearing roller that was found to have micro pitting

#### Macro Pitting

While micro pitting is typically found on races and/or rollers, macro pitting is typically found on the inner race of a bearing (as that is very commonly the most stressed component of the bearing), but still can be found on the rollers and outer race in some cases. If macro pits are small enough and in small quantity, they can be ok to run with periodic inspections to assess progression. Once macro pitting is determined to be progressive, the bearing will eventually need to be replaced.

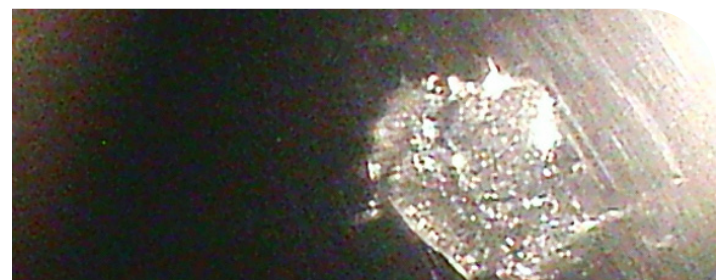

Figure 23: Bearing race with macro pitting

### Spalling

Spalling in bearings can be initiated by both surface and subsurface defects. Spalling in bearings, like in gearing, can be the result of the coalition of macro pits. This failure mode can have various shapes and depth, but in every case, once a bearing has spalled the failure mode will progress. A replacement plan for the damaged bearing should be put in place and prioritized based on the level of progression.



Figure 24: Bearing race with severe spalling

### Fracturing/Cracks

Cracks in bearings usually appear axial in nature. Some are more obvious as shown in Figure 25, while others are more difficult to spot as in Figure 26. They are often caused by white etch areas found in the microstructure of the bearing that can form over time. There are many contributing factors to the initiation and progression of white etch cracking (WEC), such as oil film thickness, oil composition, hoop stress, fatigue stress, and others. Once a bearing has cracked, the crack will cause a stress riser, and eventually lead to pitting and very quickly turn to spalling. A bearing with a through crack will also lose its fit to the shaft, which may initiate other failure modes within the gearbox. A bearing that is found to have a crack should be replaced as quickly as possible.

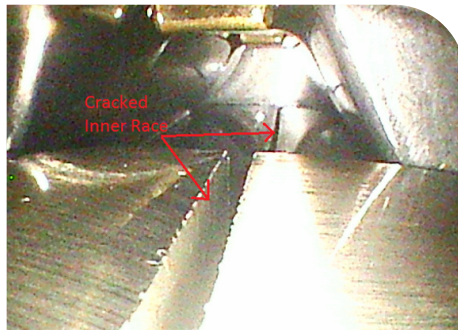

Figure 25: Bearing inner race with a pronounced axial crack

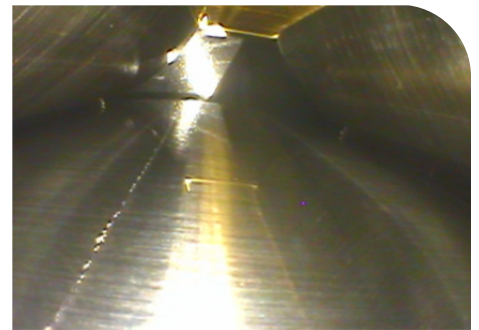

Figure 26: Bearing inner race with a subtle axial crack



# 6 Maintenance

Routine maintenance is necessary for all gearboxes. Typically, the gearbox OEM (Original Equipment Manufacturers) will provide recommendations for each specific gearbox. Below is what is typically recommended:

Every 6 months:	Annually:
<ul style="list-style-type: none"> <li>▪ Oil sampling. Tests should include the following:               <ul style="list-style-type: none"> <li>▪ Ferrous debris test using PQI (ASTM D8184) or Direct Reading (DR) Ferrography</li> <li>▪ Viscosity @ 40 deg C (ASTM D445)</li> <li>▪ Acid Number (ASTM D664m)</li> <li>▪ Water In Petroleum Products (ASTM D6304)</li> <li>▪ Metals by ICP AES</li> <li>▪ Particle Count</li> </ul> </li> <li>▪ Perform magnet sweep of filter.</li> <li>▪ Change inline short style oil filters.</li> <li>▪ Check desiccant air breathers and replace them, as necessary.</li> <li>▪ Visual gear inspection via inspection cover removal.</li> </ul>	<ul style="list-style-type: none"> <li>▪ Magnetic dipstick inspection on gearboxes that have them.</li> <li>▪ Clean heat exchanger fins.</li> <li>▪ Check hoses for leaks, dry-rotting, or signs of wear from rubbing contact.</li> <li>▪ Perform visual inspection for leaks.</li> <li>▪ Clean the nacelle.</li> <li>▪ Inspection for foaming level.</li> <li>▪ Visually inspect gearbox rubber supports.</li> <li>▪ Check if there is any abnormal noise present while gearbox rotates.</li> </ul>

**Offline filter systems** incorporate 3-to-6-micron filters that should be changed based on turbine manufacturer’s recommendation.

## Oil Sampling & Testing

The analysis of lubricating oil can provide valuable insight when done systematically. Laboratories often offer training and detailed work procedures specific to the collection of the samples. General guidelines below are not complete nor specific to any design.

- Cleanliness is critical. Sample bottles, sample port, and work area must be clean. Enough oil should be allowed to drain from sample port to ensure standing oil from sample port line is purged prior to collecting representative sample.
- Collecting a sample downstream of filters can provide information about the lubricating oil being delivered to the gears and bearings. Collecting a sample upstream of filtration can provide information about the wear debris and potential contaminants within the system.
- Testing and analysis methods for basic lubricating oil and grease will vary in testing type, process, lab equipment, and even what to look for. All generate different costs and benefits. Common tests include water content, particle contamination content of metals and silica, chemical contamination, oxidation, and viscosity. Additional common tests include oil cleanliness (ISO 4406/ ANSI 6006 require -/16/13 in an operating gearbox), viscosity, water content, wear metals, and oil oxidation. Refer to ANSI/AWEA 6006 for additional details.
- Consistency is important. Results vary from lab to lab so developing a partnership with one effective lab is advisable.
- Reporting should be consistent, efficient, and alarms generated when action is required.
- Contact the turbine OEM or your oil supplier for recommended oil analysis limits and interpretation.

## Gearbox Oil Level

It is critical to ensure the gearbox oil level is within the manufacturer's tolerance. In some designs the variance might be only 5 of 100 gallons, or approximately 5%. Overfilling is a leading cause of seal damage and oil leaks. Under-filling can cause a lack of lubrication and overheating. Due to the mounting angle, the proper oil level can only be achieved when the gearbox is installed in the nacelle.

### To ensure that the proper oil level is achieved:

- Always refer to the gearbox nameplate and original gearbox manufacturer to obtain the correct oil quantity, viscosity, and oil filling procedure.
- Some manufacturer's instructions include positioning the planet gears before checking oil level.
- Verify that the gearbox is mounted correctly before performing the oil level check.
- Due to the volume of oil in the cooling and filtration circuits, the drivetrain must rest for at least 30 minutes to allow oil to drain back into the gearbox sump.
- The ideal oil level is often exactly halfway between the minimum and maximum marks on the oil level sight glass.
- Cleanliness is critical and cleanliness levels are specified by equipment manufacturers according to the ISO specifications.
- Use clean equipment to transfer oil
- Know the cleanliness level of the oil to be added to the gearbox. New oil is not necessarily within specified levels.
- Use of a filter-transfer pump is recommended over pouring oil

## Gearbox Oil Condition Management

Oil condition can be expected to degrade over time. Managing oil condition in day-to-day operations is dependent on anomalies identified from regular oil sampling as well as oil and gearbox manufacturer recommendations. More advanced oil condition monitoring tools such as Oil Quality Sensors are also available. These sensors measure electrochemical impedance to track and trend the health of gear oil. This allows operators to monitor for oil breakdown and identify contaminants in real time, bridging the data gap between the common 6 month oil sampling intervals.

## Gearbox Oil Changes

Changing the gearbox oil is sometimes necessary and should be based on oil manufacturer recommendations. When performing oil changes, it is extremely important to drain and flush as much old oil as possible from the gearbox prior to refilling it with new oil. Post-oil change samples are drawn about one week after the oil change to ensure that the oil change was successful. If the post-change oil sample shows excessive residual content of the old oil, remedial action can be taken.





# 7 Condition Monitoring Systems

There are several condition monitoring systems designed to detect failures and damage prior to a catastrophic failure. These systems include:

- 1. Thermocouples:** These are placed in crucial areas of the gearbox to monitor temperature conditions. These locations are typically high-speed bearings and oil sumps. These temperatures will hint at if the gearbox is operating at a normal temperature per each location they monitor.
- 2. Manometers:** These pressure sensors are usually hooked up to the oil manifold of each gearbox to verify proper oil flow to the force-fed locations of the gearbox (bearings and gear meshes).
- 3. Oil Wear Debris Sensors:** These sensors are able to detect, size, and classify metal wear particles as either ferrous or non-ferrous metal as they are carried in the oil from the gearbox to the lubrication pump and filter assembly. By detecting these particles, the sensor can provide an indication of a gear or bearing fault. Particle quantity and size increases are expected to rise as damage progresses.
- 4. Vibration Accelerometers:** These sensors are placed in different areas on the gearbox to monitor vibrations seen in the boxes. The frequencies monitored are those of gear meshes and bearing rotation frequencies. If certain damages arise during operation, these vibration sensors will be able to detect changes in those frequencies and alert the operator of the need to visually inspect the area.
- 5. Electrical Signature Analysis:** Measurements or monitoring of generator voltage and current are used to measure frequencies and torque seen in gear boxes. Similar to vibration, frequencies associated with gear defects or wear and bearing rotation frequencies are monitored. Single detection of frequencies may indicate wear and changes over time indicate potential defects that can be visually inspected. Condition is determined based on peak voltage and current with amplitude of defects identified in decibels down to the associated peaks allowing for the detection of change across varying loads and relative torsional peaks.
- 6. Bore Scope Inspection:** This is a visual inspection with a bore scope. These inspections are often used to confirm the location and severity of anomalies identified by other condition monitoring methods. Regular borescoping can also be used to monitor damage progression over time, but is often limited by the availability of resources to perform continuous inspections across a site.

Operators often utilize a combination of the above methods to support the identification and management of drivetrain failures. The selection of monitoring methods is dependent upon several factors such as cost of implementation and the availability of expertise.



# 8 Common Bore Scope Inspection Practices

It is highly recommended that bore scope inspections be carried out by those who have had formal bore scope training. There are a few companies in the industry who offer this training. Developing an understanding of typical wear, failure modes, progression, and how to use visible indications to discover hidden damage will reduce inspection time while increasing discovery.

## Typically, the following will be needed for a proper bore scope inspection:

- Bore scope with 3mm (about 0.12 in) or 4mm (about 0.16 in) probe. 6mm (about 0.24 in) probes can be used for better pictures of gearing, but the larger size will limit the areas, specifically bearings, that you can get to.
- A digital camera is helpful to capture images of the gearbox exterior, sight glass oil level and ID tag, but is also a better option than borescope for capturing images of the gear teeth visible from the inspection hatch.
- Alcohol wipes for cleaning the lens.
- Microfiber towels to assist with cleaning the probe and tubes.
- Bendable tubing such as automotive fire suppression lines to help guide the probe to deeper components in the gearbox.
- Gearbox schematic from gearbox supplier.
- Wrenches that are needed for removing covers and plugs. Some designs require hex keys while others use hex head bolts.
- A putty knife, solvent, and a sealant may be required to remove and replace the inspection hatch seal. If O-ring or gasket types of seals are in place and damaged upon removal, they may require replacement. Exercise caution to prevent used seals or sealant from falling into gearbox.

## Additional guidelines:

- Assure the proper LOTO is executed prior to exposing rotating equipment for inspection. For gearboxes this typically includes engaging the rotor lock and shutting off lube oil pumps.
- Wind and gusts of wind can cause gear teeth to shift, even when rotor locking systems are engaged. Care must be taken when performing a bore scope to not get the probe pinched between components.
- Oil will be prominent everywhere, so alcohol wipes and microfiber towels are necessary to get clear pictures.
- Extra care must be taken to ensure images are bright, clear, and in focus. Too much light or lack-there-of makes report analysis and intervention recommendations difficult.
- While close-up images are important, distance photos demonstrating perspective are critical and often the most difficult to capture. These are necessary to assure accurate identification of failure modes, avoiding false positives.
- To analyze the condition of the gearbox properly, it is important to inspect as much of each gear and bearing as possible, as there could be damage contained to one area of a component that might not be seen in another area of that component. For this reason, inspectors must also understand many types of damage as some minor damages can point to severe damage progression in other parts of the gearbox.
- It will be necessary to rotate the gears to inspect all gear teeth. During this process, the oil level can be lowered slightly by rotating as much of the planet gears out of the oil as possible. This should be done prior to engaging the rotor locking systems.
- Lowering the oil level will expose additional areas for better inspection coverage throughout the gearbox. Depending upon design, 30% - 70% of the ring gear will be accessible for inspection.
- Depending on the gear ratios, the turbine rotor may have to be rotated up to 50 revolutions to view every planet gear tooth. It is common for the same teeth to present themselves in the inspection area as the planet carrier rotates. Unfortunately, a few planet gear teeth do not typically represent the condition of the others.
- A guide tube is usually necessary to access the sun pinion. This is an area prone to breaking borescope lenses so the rotor locking system must be engaged. For these reasons, it may not be practical to inspect every tooth on the sun pinion. Typically, a few sun pinion teeth represent the condition of the others.
- It is important to distinguish between the loaded and unloaded gear tooth flanks. When found, gear tooth wear and damage information should include rotor side / generator side location information.

- It is also helpful if the inspector records the specific location of any noticeable wear or damage.
- Bearing inspections should always include the inner ring, outer ring, and rolling element contact surfaces. Cages and additional rows of rolling elements may prevent access for inspection and should be noted as such.
- Implement a systematic route approach, a natural “order of operations” that creates consistency in the discovery and reporting processes. One process in use is to begin by capturing an image of the gearbox ID tag and then capture an image of a pre-printed label for each component prior to inspecting those components (i.e., “IMS RS BRG”).
- It is important to properly label photos, as some gears and bearings will look very similar and might be indistinguishable if not labeled.
- It is recommended that inspector’s author their own reports whenever possible to avoid misdiagnosed photos and miscommunications.
- Utilize standard nomenclature from ANSI/AMBA/ISO 15243-2017 (bearings) and ANSI/AGMA 1010-F14 (gears).
- Depending upon gearbox type, multiple access ports may be available to aid inspection. In addition to the standard inspection hatch, some models include threaded and capped inspection holes on the rotor side of the planetary housing section.

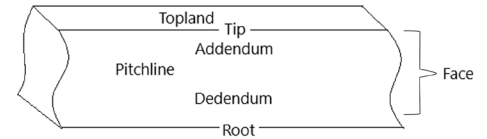

Figure 27: Gear tooth diagram

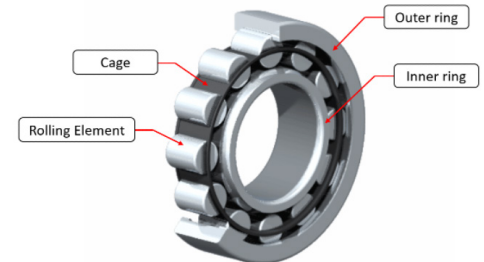

Figure 28: Bearing diagram

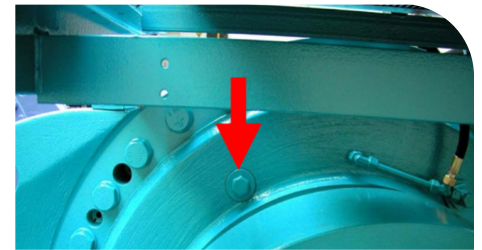

Figure 29: Example of inspection port

### Prior to borescope inspection:

- When the wind allows, it can be valuable for the inspectors to stop at the base of the turbine and listen to it operate. Especially during full-production winds, many indications of potential drive train problems can be heard from the base of the tower.
- A visual inspection of the oil filter element, filter housing, and strainer basket (when included) can provide clues such as particle debris which should be collected. A magnet can also be used to sweep these areas.
- To prevent the possibility of foreign objects falling into the gearbox, prior to opening the inspection hatch, the area should be secured by removing any loose items including anything attached to the technicians. Extra caution should be used to contain the bolts and washers used to secure the inspection hatch.
- If foam is visible in significant quantities, it will be visible upon removal of the inspection hatch and should be noted.
- Using a magnet on a telescoping or articulating reach tool to sweep the gearbox from the inspection hatch can provide insight into ferrous debris.
- A visual inspection from the inspection hatch and a digital camera can be used to locate any signs of sludge formation which may represent a separation of lubricant additives.
- A visual inspection of the lubricating oil collected in a clear glass jar may allow for detection of water emulsion, suspended water particles, particle debris, or other foreign contamination.
- The inspector should also note any burnt or foul smell from the lubricating oil.
- A digital camera should be used to capture images of any gear teeth visible from the inspection hatch.

## Common Misdiagnosis:

Borecope inspections are fraught with challenges and capturing a great image is one of the most difficult to overcome. Even if the lens is clean of oil and free from scratches, limited light, focal length, and fisheye images can make identification of the extent of wear or damage, almost impossible for the inexperienced. Unfortunately, “false positives” are not unusual. Below are some real-world examples.

The image on the below left (Figure 30) shows a scratch on the gear tooth. The image on the below right (Figure 31) demonstrates the shiny result of micro pitting along a grinding asperity. Both were mis-diagnosed as gear tooth cracks.



Figure 30: Scratch on gear tooth



Figure 31: Straight-line micro pitting

The image below left (Figure 32) is a common bearing with a black oxide coating (conversion). The shiny track in the center of the roller (foreground) is sometimes misdiagnosed as micro pitting or debris tracks. When viewed with the unaided eye under normal lighting (below right), it is evident that the black oxide had worn away in the loaded zone, but there is nothing as severe as damage.

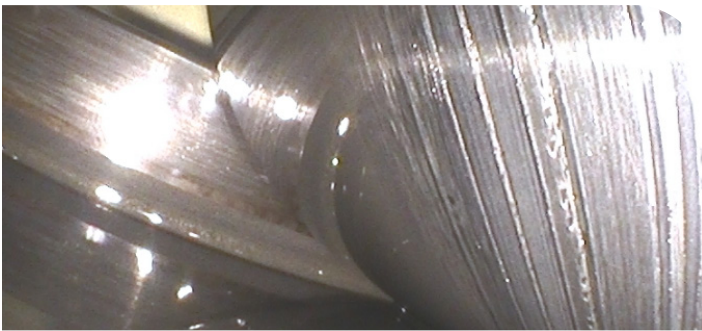

Figure 32: Black Oxide Coating worn away, depicted via bore scope on the left, and unaided visual on the right

In some cases, early signs of problems can be almost invisible to the less experienced inspector. The below image (Figure 33) of pinion gear teeth looks very clean with almost no signs of wear. Upon close inspection significant but tiny macro pits have developed in the dedendum of the gear teeth. This should be flagged and monitored for progression.

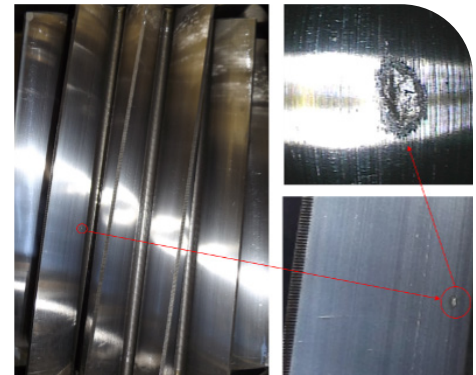

Figure 33: Small macro pit as seen by normal visual, and through a bore scope